

# G-SEK100-1FE12

Technical specifications



### Operating mode:

The SEK upper assembly is mounted on the SHW upper assembly.  
The SEK lower assembly is mounted on the SHW lower assembly accordingly. The SEK is automatically coupled by the mechanical connection of the exchange system.

### Advantages:

- Mechanical and electric connections are established simultaneously
- Withstands up to 1,000,000 changing cycles
- Individual wiring and coding of the interchange parts

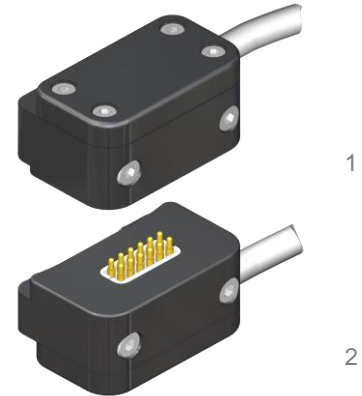

Technical specifications		SEK100-1FE12
Basic material		Al, anod.
Compatible with		<b>SHW 063, 080, 100 ; AC063</b>
Adaptable to		<b>SHW 125, 160</b>
Width x depth x height [mm]		38 x 25,5 x 40
Signal ducts		12
Rated current I [A]		2
Rated voltage U (max. voltage) [V]		63 (120)
Contact resistance per pole R [mΩ]		20
Contact durability (cycles)		50.000
Mass [kg]	upper assembly	0,04
	lower assembly	0,04
Protection class (higher requirement only on request)		IP40
Operating temperature range [°C]		-30 to +120

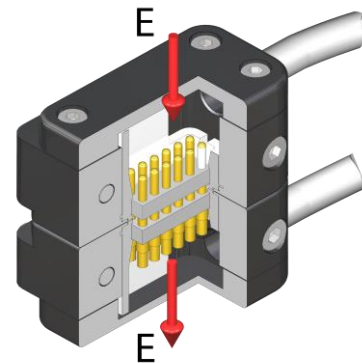

Pos.	Description
1	Upper assembly
2	Lower assembly
3.1	Upper cap
3.2	Lower cap
4	Insulation frame
5	Electric socket
6	Electric spring pins
8	Screw
9	Mounting screw
10	Cable (optional)

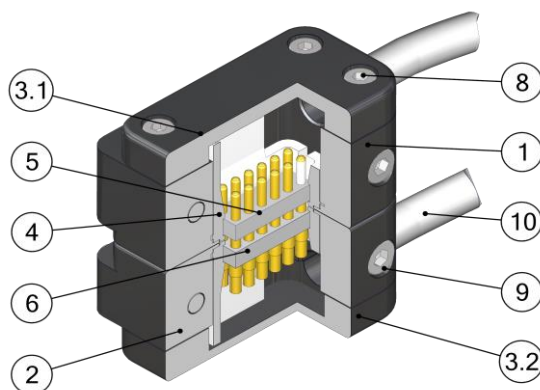

**SEK energy feed-through with spring contacts...**

G-SEK100-O-1FE12	upper assembly, electrical socket, 12 poles
G-SEK100-O-1FE12-2000OE	upper assembly, electrical socket, 12 poles, cable L= 2000 mm, open end
G-SEK100-O-1FE12-300-M12	upper assembly, electrical socket, 12 poles, cable L= 300 mm, plug M12
G-SEK100-O-1FE12-300-M8	upper assembly, electrical socket, 12 poles, cable L= 300 mm, socket M8, angled
G-SEK100-O-1FE12-300-M8-SW	upper assembly, electrical socket, 12 poles, cable L= 300 mm, plug M8, angled
G-SEK100-U-1FE12	lower assembly, electrical spring pins, 12 poles
G-SEK100-U-1FE12-2000OE	lower assembly, electrical spring pins, 12 poles, cable L= 2000 mm, open end
G-SEK100-U-1FE12-300-M12	lower assembly, electrical spring pins, 12 poles, cable L= 300 mm, socket M12
G-SEK100-U-1FE12-40-M8	lower assembly, electrical spring pins, 12 poles, cable L= 40 mm, plug M8, angled
G-SEK100-U-1FE12-40-M8-BW	lower assembly, electrical spring pins, 12 poles, cable L= 40 mm, socket M8, angled

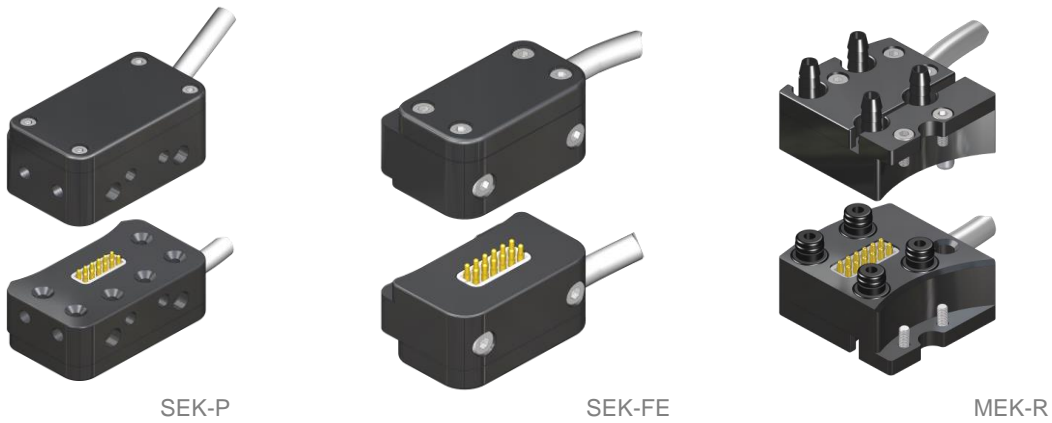

Products	Electrical connection	Cable variants
SEK-P / SEK-FE / MEK-R upper assembly	Electric strip, female (suitable for spring contacts)	M8-bushing, M12-plug, open end
SEK-P / SEK-FE / MEK-R lower assembly	Electric strip, male (including spring contacts)	M8-plug, M12-bushing, open end

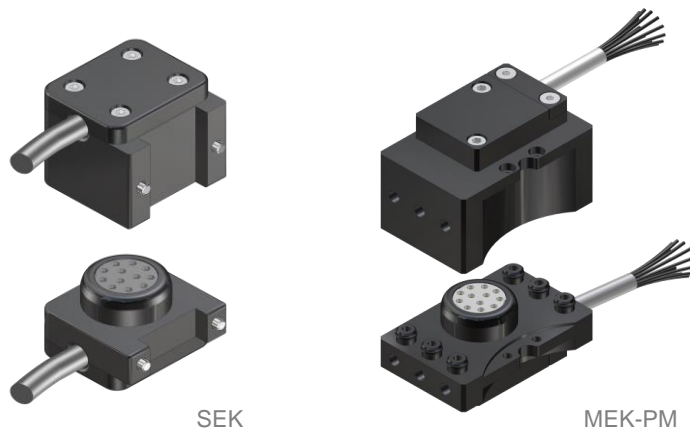

Products	Electrical connection	Cable variants
SEK / MEK-PM upper assembly	Insulating body with pin contacts	M8-bushing, M12-plug, open end
SEK / MEK-PM lower assembly	Insulating body with socket contacts	M8-plug, M12-bushing, open end



As standard, we offer the listed products for self-soldering.  
The contact assignment of the pre-assembled connections can be found in the following data sheets.

Ordering example: G-SEK100-O/U-1FE12  
G-MEK063-O/U-6PM5-1E12

FEB12	
Electric strip, female	
12-poles (female)	
Strip 2x 6 rows	
Rated current per pole: 2A	
Contact resistance < 20mΩ	
Contact spacing: 2,54mm	
Gilded	
Solder connection	

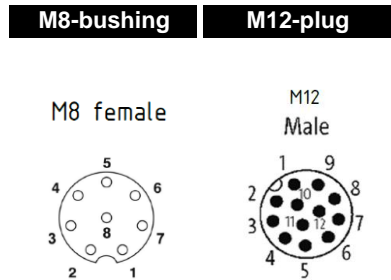
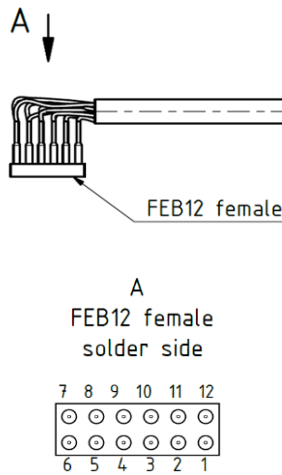

**300-M8**  
300mm cable, circular connector M8-bushing

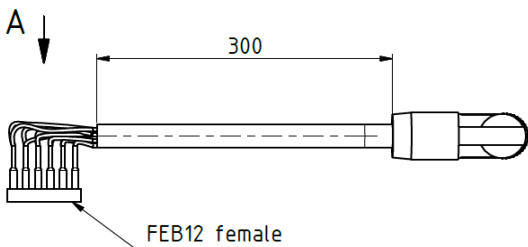

pin assignment	
1	white
2	brown
3	green
4	yellow
5	grey
6	pink
7	blue
8	red
9	---
10	---
11	---
12	---

M8-bushing
8 poles (female)
Cable: drag chain suitable
According to IEC-61076-2-104
Operating voltage: max 30 V
Rated current (at 30°): 1,5 A
Temperature range: -25...85°C
Cable: PUR halogen-free

included in: G-SEK100-O-1FE12-300-M8  
G-MEK063-O-4PR4-1FE12-300-M8

spare part: EG-MEK-FEB12-300-M8-BW

**300-M12**  
300mm cable, circular connector M12 plug

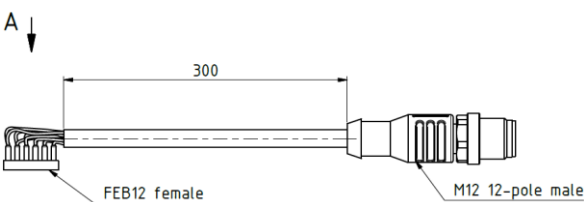

FEB12 female	colour	M12 male
1	white	3
2	brown	1
3	green	4
4	yellow	6
5	grey	8
6	pink	5
7	blue	2
8	red	9
9	black	7
10	violet	10
11	grey/pink	11
12	blue/red	12

M12-plug
12 poles (male)
Cable: drag chain suitable
12 x 0,14mm <sup>2</sup> , Ø5,6
According to IEC-61076-2-104
Operating voltage: max 30 V
Rated current (at 30°): 1,5 A
Insulation resistance: ≥10 <sup>3</sup> Ω
Temperature range: -25...85°C
Cable: PUR halogen-free

included in: G-SEK100-O-1FE12-300-M12  
G-MEK063-O-4PR4-1FE12-300-M12

spare part: EG-MEK-FEB12-300-M12

**2000-OE**  
2000mm cable, open end

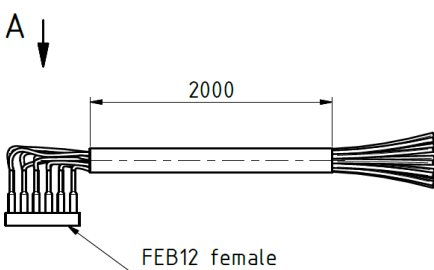

pin assignment	
1	white
2	brown
3	green
4	yellow
5	grey
6	pink
7	blue
8	red
9	black
10	violet
11	grey-pink
12	blue-red

Open end
12 poles
Cable: drag chain suitable
Outer-Ø (D): 5,6 ± 0,2mm
Nominal voltage: ≤300V
Bending radius:
- fixed installation: >5 x D
- in motion: >10 x D
Wire cross-section: 12 x 0,14mm <sup>2</sup>
Insulation resistance: ≥10 <sup>3</sup> Ω
Temperature range: -25...85°C
Material: PUR halogen-free
Rated current (at 30°): 2 A

included in: G-SEK100-O-1FE12-2000-OE  
G-MEK063-O-4PR4-1FE12-2000-OE

spare part: EG-MEK-FEB12-2000OE

FES12
Electric strip, male
Spring contacts
12 poles (male)
Strip 2x 6 rows
Spring force: 0,6N at 0,7mm
Rated current per pole: 2A
Contact resistance < 20mΩ
Contact spacing: 2,54mm
Gilded
Solder connection
Max stroke: 2,4mm

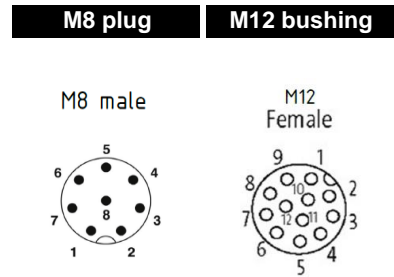
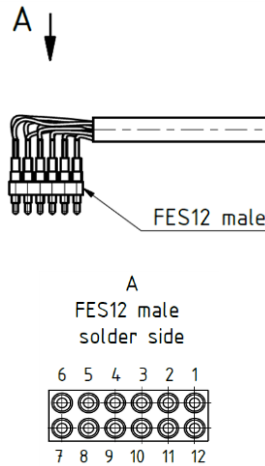

**40-M8**  
40mm cable, circular connector M8 plug

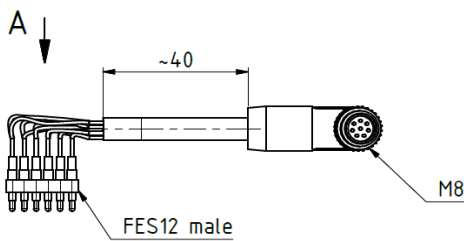

pin assignment	
1	white
2	brown
3	green
4	yellow
5	grey
6	pink
7	blue
8	red
9	---
10	---
11	---
12	---

M8 plug
8 poles (male)
Cable: drag chain suitable
Operating voltage: max 30 V
Rated current (at 30°): 1,5 A
Temperature range: -25...85°C
Cable: PUR halogen-free

included in: G-SEK100-U-1FE12-40-M8  
G-MEK063-U-4PR4-1FE12-40-M8

spare part: EG-MEK-FES12-40-M8-SW

**300-M12**  
300mm cable, circular connector M12 bushing

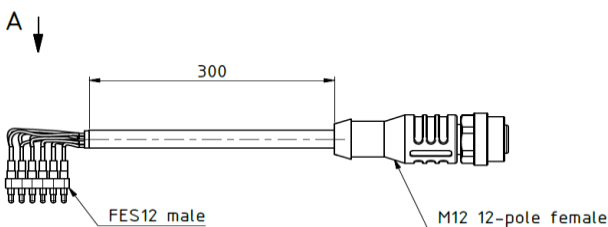

FES12 male	colour	M12 fem.
1	white	3
2	brown	1
3	green	4
4	yellow	6
5	grey	8
6	pink	5
7	blue	2
8	red	9
9	black	7
10	violet	10
11	grey/pink	11
12	blue/red	12

M12 bushing
12 poles (female)
Cable: drag chain suitable
12 x 0,14mm <sup>2</sup> , Ø5,6
According to IEC-61076-2-104
Operating voltage: max 30 V
Rated current (at 30°): 1,5 A
Insulation resistance: ≥10 <sup>3</sup> Ω
Temperature range: -25...85°C
Cable: PUR halogen-free

included in: G-SEK100-U-1FE12-300-M12  
G-MEK063-U-4PR4-1FE12-300-M12

spare part: EG-MEK-FES12-300-M12

**2000-OE**  
2000mm cable, open end

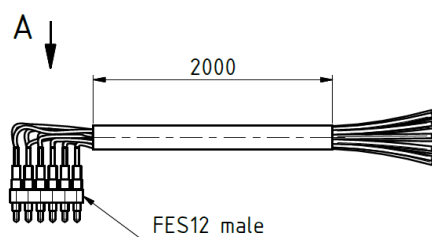

pin assignment	
1	white
2	brown
3	green
4	yellow
5	grey
6	pink
7	blue
8	red
9	black
10	violet
11	grey-pink
12	blue-red

Open end
12 poles
Cable: drag chain suitable
Outer-Ø (D): 5,6 ± 0,2mm
Nominal voltage: ≤300V
Bending radius:
- fixed installation: >5 x D
- in motion: >10 x D
Wire cross-section: 12 x 0,14mm <sup>2</sup>
Insulation resistance: ≥10 <sup>3</sup> Ω
Temperature range: -25...85°C
Material: PUR halogen-free
Rated current (at 30°): 2 A

included in: G-SEK100-U-1FE12-2000-OE  
G-MEK063-U-4PR4-1FE12-2000-OE  
spare part: EG-MEK-FES12-2000OE

**IKS12**

- Insulating body with pins
- 12 poles (male)
- Rated current per pole: 9A
- Contact resistance < 3mΩ

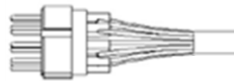

**M8 bushing      M12 plug**

M8 female

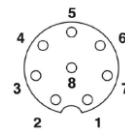

M12 Male

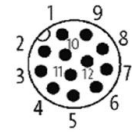

**300-M8**

300mm cable, circular connector M8 bushing

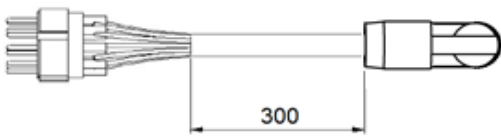

pin assignment	
1	white
2	brown
3	green
4	yellow
5	grey
6	pink
7	blue
8	red
9	---
10	---
11	---
12	---

**M8 bushing**

- 8 poles (female)
- Cable: drag chain suitable
- According to IEC-61076-2-104
- Operating voltage: max 30 V
- Rated current (at 30°): 1,5 A
- Temperature range: -25...85°C
- Cable: PUR halogen-free

included in: G-SEK100-O-1E12-300-M8  
G-MEK063-O-6PM5-1E12-300-M8

spare part: EG-MEK-IKS12-300-M8-BW

**300-M12**

300mm cable, circular connector M12 plug

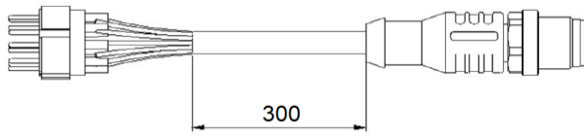

pin assignment	
1	brown
2	blue
3	white
4	green
5	pink
6	yellow
7	black
8	grey
9	red
10	violet
11	grey-pink
12	blue-red

**M12 plug**

- 12 poles (male)
- Cable: drag chain suitable
- 12 x 0,14mm<sup>2</sup>, Ø5,6
- According to IEC-61076-2-104
- Operating voltage: max 30 V
- Rated current (at 30°): 1,5 A
- Insulation resistance: ≥10<sup>3</sup>Ω
- Temperature range: -25...85°C
- Cable: PUR halogen-free

included in: G-SEK100-O-1E12-300-M12  
G-MEK063-O-6PM5-1E12-300-M12

spare part: EG-MEK-IKS12-300-M12

**2000-OE**

2000mm cable, open end



pin assignment	
1	brown
2	blue
3	white
4	green
5	pink
6	yellow
7	black
8	grey
9	red
10	violet
11	grey-pink
12	blue-red

**Open end**

- 12 poles
- Cable: drag chain suitable
- Outer-Ø (D): 5,6 ± 0,2mm
- Nominal voltage: ≤300V
- Bending radius:
  - fixed installation: >5 x D
  - in motion: >10 x D
- Wire cross-section: 12 x 0,14mm<sup>2</sup>
- Insulation resistance: ≥10<sup>3</sup>Ω
- Temperature range: -25...85°C
- Material: PUR halogen-free
- Rated current (at 30°): 2 A

included in: G-SEK100-O-1E12-2000-OE  
G-MEK063-O-6PM5-1E12-2000-OE  
spare part: EG-MEK-IKS12-2000-OE

**IKB12**

- Insulating body with bushings
- 12 poles (female)
- Rated current per pole: 9A
- Contact resistance < 3mΩ

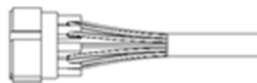

**M8 plug**

**M12 bushing**

M8 male

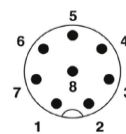

M12 Female

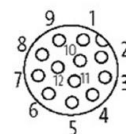

**40-M8**

40mm cable, circular connector M8 plug

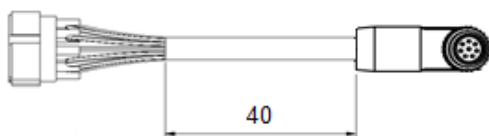

pin assignment	
1	white
2	brown
3	green
4	yellow
5	grey
6	pink
7	blue
8	red
9	---
10	---
11	---
12	---

**M8 plug**

- 8 poles (male)
- Cable: drag chain suitable
- Operating voltage: max 30 V
- Rated current (at 30°): 1,5 A
- Temperature range: -25...85°C
- Cable: PUR halogen-free

included in: G-SEK100-U-1E12-40-M8  
G-MEK063-U-6PM5-1E12-40-M8

spare part: EG-MEK-IKB12-40-M8-SW

**300-M12**

300mm cable, circular connector M12 bushing

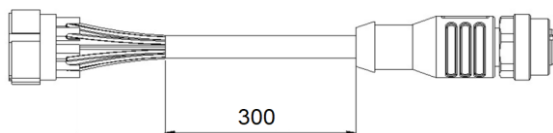

pin assignment	
1	brown
2	blue
3	white
4	green
5	pink
6	yellow
7	black
8	grey
9	red
10	violet
11	grey-pink
12	blue-red

**M12 bushing**

- 12 poles (female)
- Cable: drag chain suitable
- 12 x 0,14mm<sup>2</sup>, Ø5,6
- According to IEC-61076-2-104
- Operating voltage: max 30 V
- Rated current (at 30°): 1,5 A
- Insulation resistance: ≥10<sup>3</sup>Ω
- Temperature range: -25...85°C
- Cable: PUR halogen-free

included in: G-SEK100-U-1E12-300-M12  
G-MEK063-U-6PM5-1E12-300-M12

spare part: EG-MEK-IKB12-300-M12

**2000-OE**

2000mm cable, open end

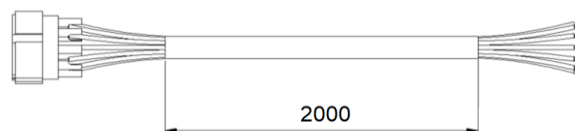

pin assignment	
1	brown
2	blue
3	white
4	green
5	pink
6	yellow
7	black
8	grey
9	red
10	violet
11	grey-pink
12	blue-red

**Open end**

- 12 poles
- Cable: drag chain suitable
- Outer-Ø (D): 5,6 ± 0,2mm
- Nominal voltage: ≤300V
- Bending radius:
  - fixed installation: >5 x D
  - in motion: >10 x D
- Wire cross-section: 12 x 0,14mm<sup>2</sup>
- Insulation resistance: ≥10<sup>3</sup>Ω
- Temperature range: -25...85°C
- Material: PUR halogen-free
- Rated current (at 30°): 2 A

included in: G-SEK100-U-1E12-2000-OE  
G-MEK063-U-6PM5-1E12-2000-OE

spare part: EG-MEK-IKB12-2000-OE