

GRIP: G-HWS100
Oberteil: G-HWS100-O-K080
Unterteil: G-HWS100-U-A080

S: HWS080
Kopf: HWK-080-000-000
Adapter: HWA-080-000-000

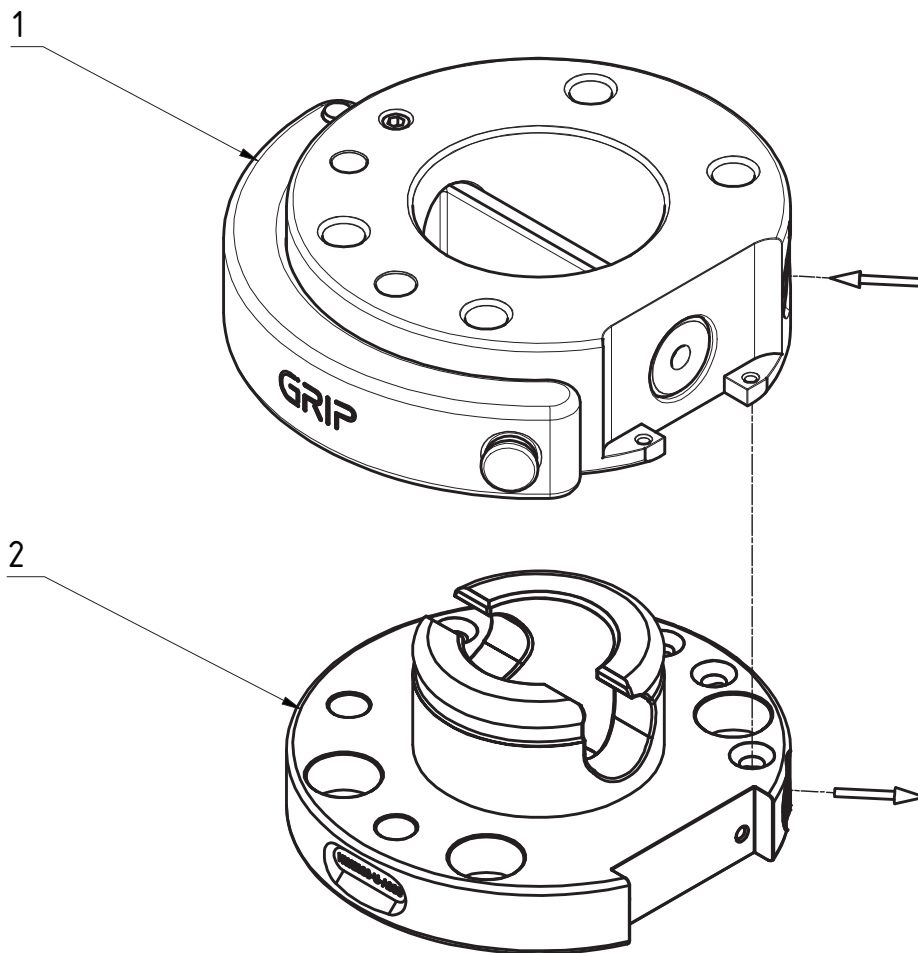

Pos.	GRIP Art.-Nr.	Beschreibung
1	G-HWS100-O-K080	Oberteil, Kopf, TK=80
2	G-HWS100-U-A080	Unterteil, Adapter, TK=80

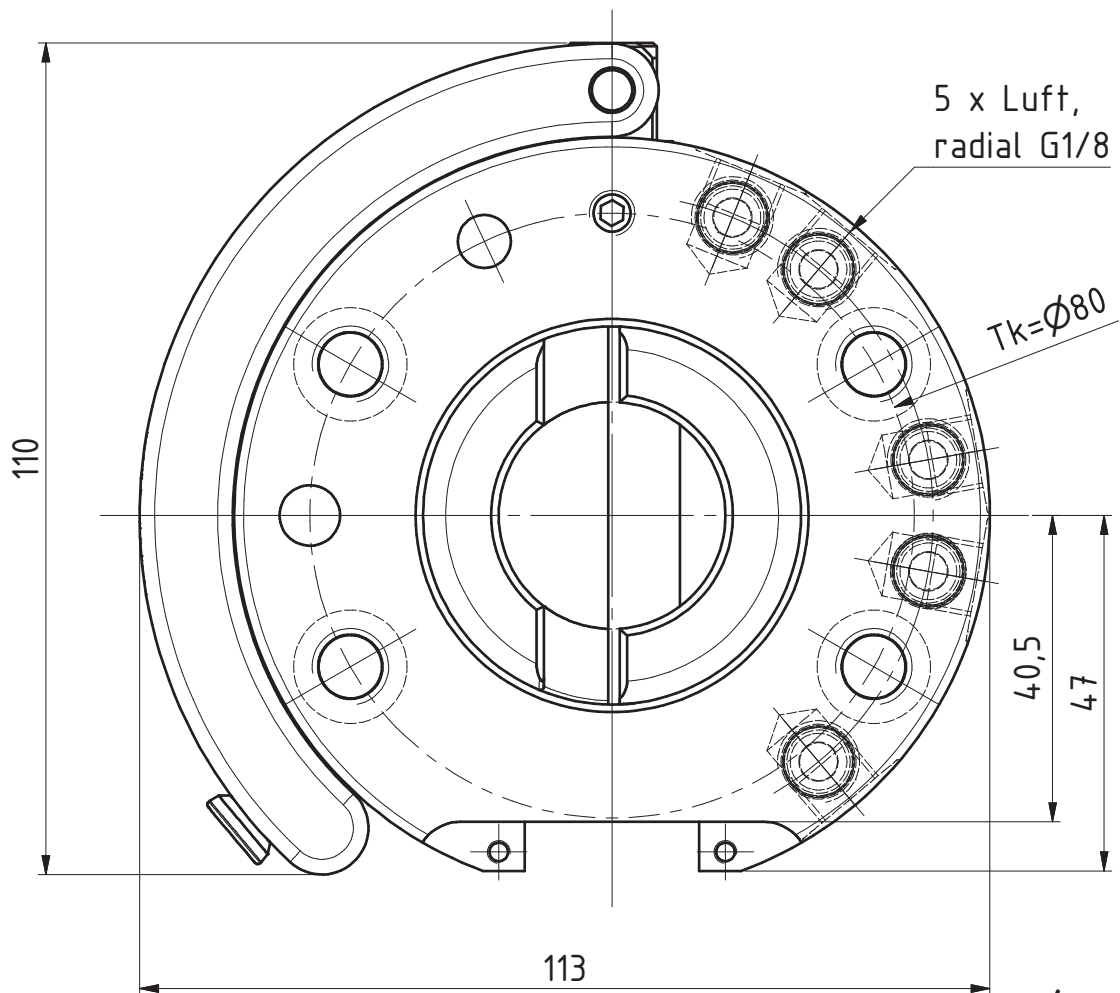
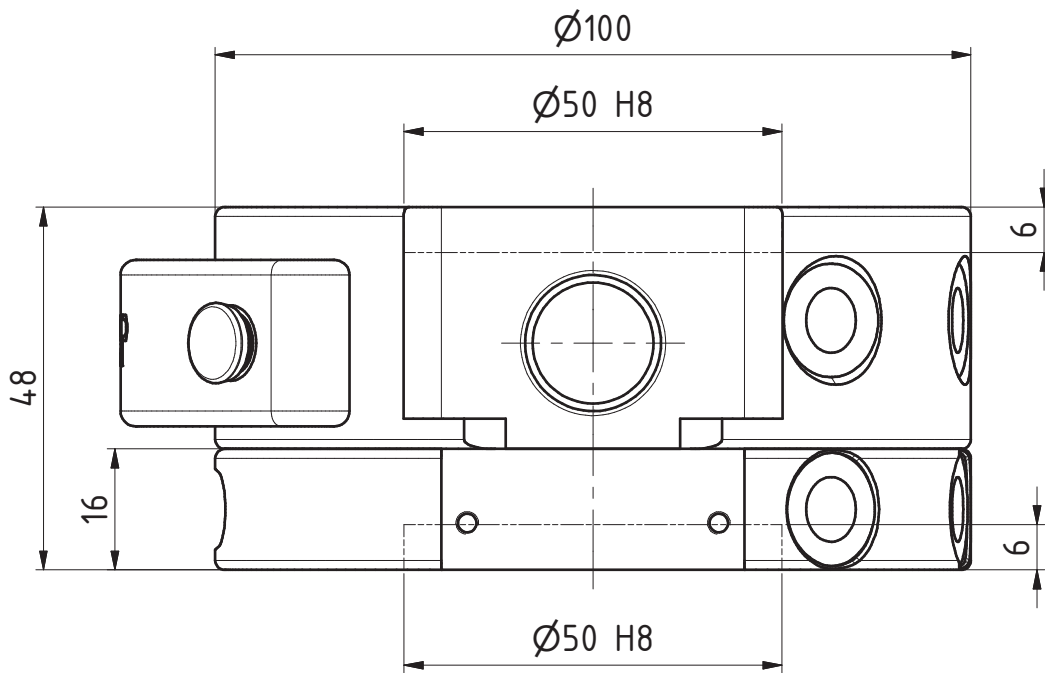

(1 : 5)

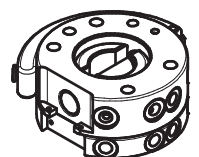

Datum 01.03.2025

Maßstab 1:1

Zeichnungsnummer

G-HWS100-2ZEP

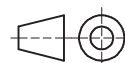

GRIP
GRIP GmbH Handhabungstechnik