

GRIP: G-HWS080  
Oberteil: G-HWS080-O-K063  
Unterteil: G-HWS080-U-A063

S: HWS063  
Kopf: HWK-063-000-000  
Adapter: HWA-063-000-000

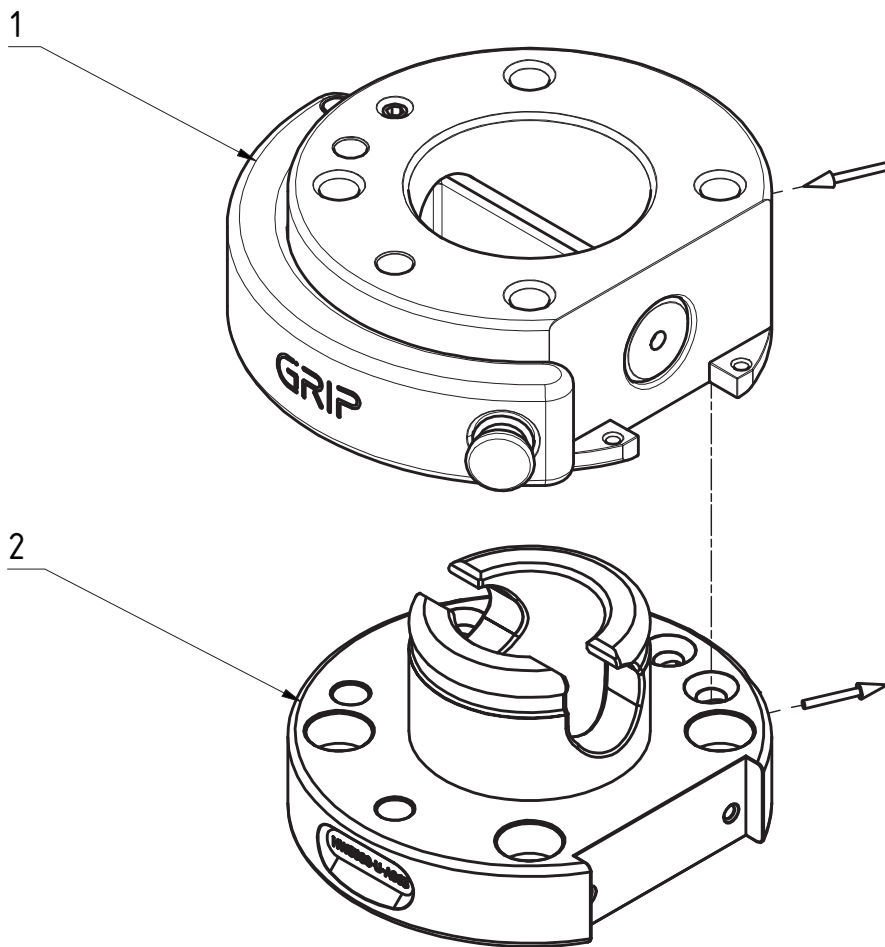

Pos.	GRIP Art.-Nr.	Beschreibung
1	G-HWS080-O-K063	Oberteil, Kopf, TK=63
2	G-HWS080-U-A063	Unterteil, Adapter, TK=63

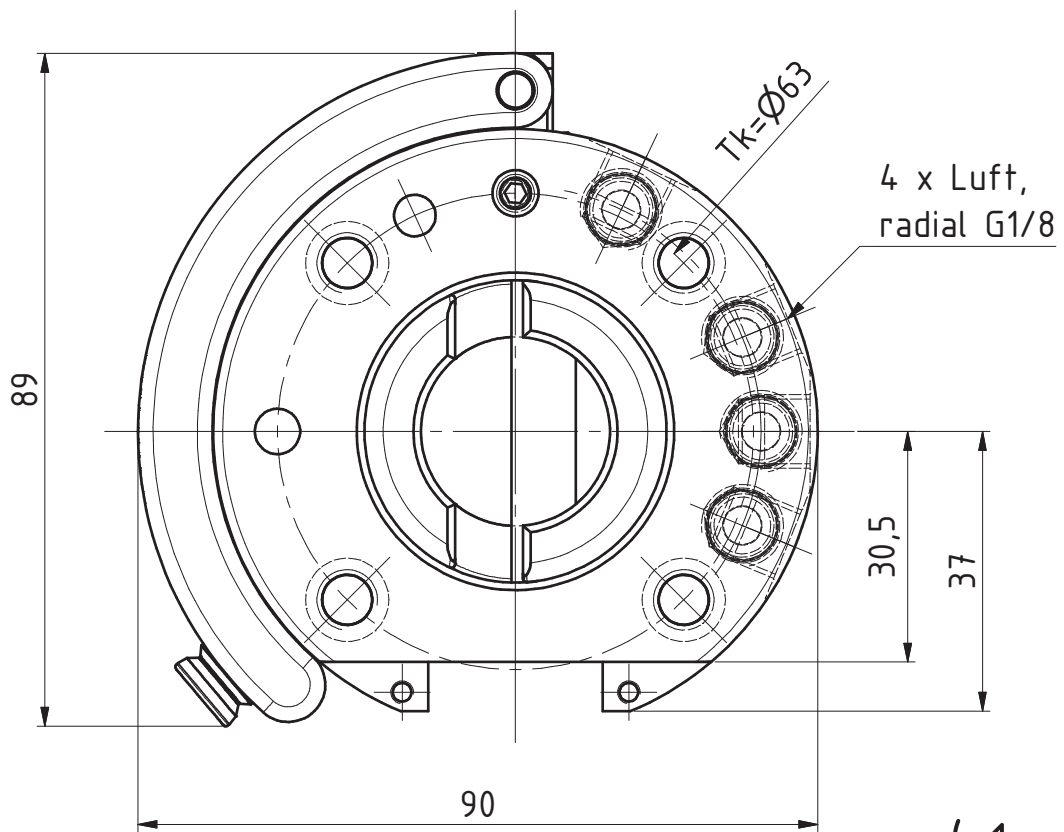
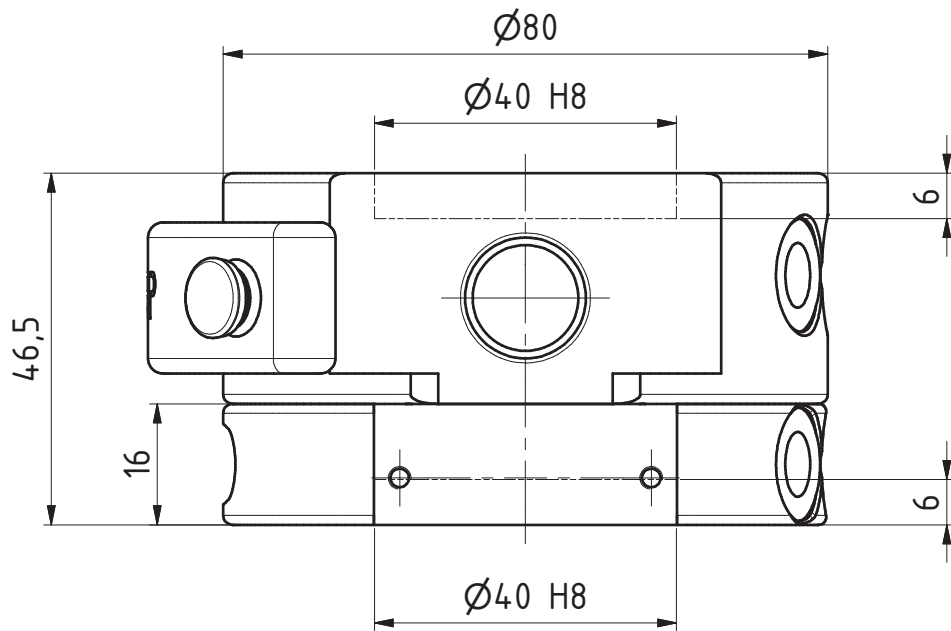

( 1 : 2 )

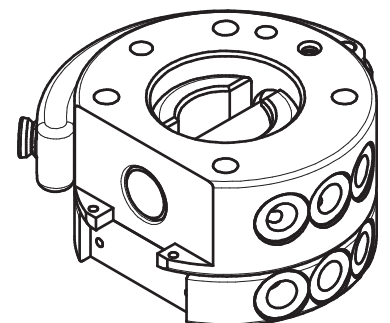

Datum 01.03.2025

Maßstab 1:1

Zeichnungsnummer

G-HWS080-2ZEP

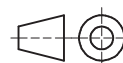

**GRIP**  
GRIP GmbH Handhabungstechnik